



art. 0160

valvola di troppo pieno a due sfere

two bowls overflow valve

soupape de trop plein à deux boules

Überlaufventil mit zwei Kugeln

válvula de llenado con dos bolas

Aspirazione massima: 8.000 lt/min
Suction capacity: 8.000 lt/min

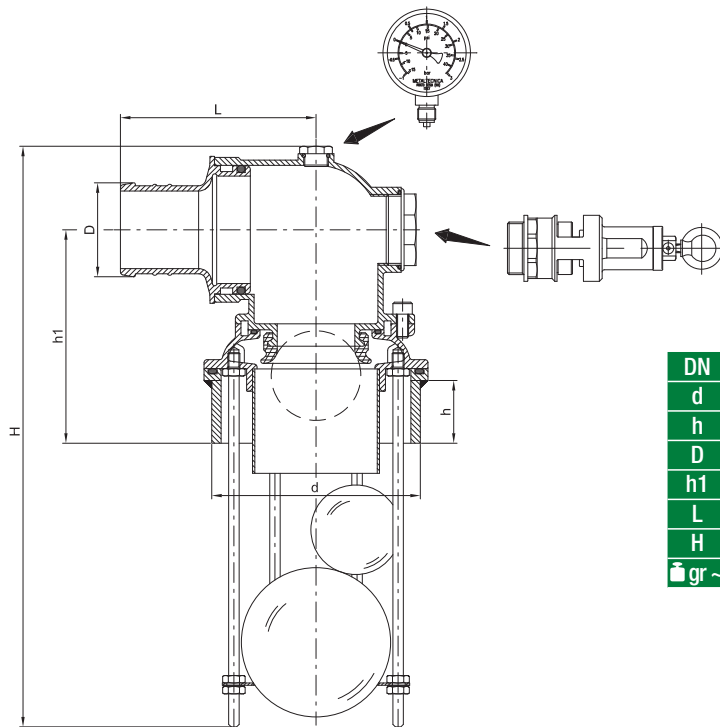

DN	45	50	60	75	80
d	140	140	140	168	168
h	50	50	50	60	60
D	45	50	60	75	80
h1	145	145	145	162	162
L	130	130	130	145	145
H	380	380	380	420	420
gr ~	6.150	6.100	6.250	8.650	8.700

Codici di ordinazione

Purchase article numbers

Valvola di troppo pieno da mm 45 a 2 sfere Two bowls overflow valve mm 45	ARZO 0160 045 000
Valvola di troppo pieno da mm 50 a 2 sfere Two bowls overflow valve mm 50	ARZO 0160 050 000
Valvola di troppo pieno da mm 60 a 2 sfere Two bowls overflow valve mm 60	ARZO 0160 060 000
Valvola di troppo pieno da mm 75 a 2 sfere Two bowls overflow valve mm 75	ARZO 0160 075 000
Valvola di troppo pieno da mm 80 a 2 sfere Two bowls overflow valve mm 80	ARZO 0160 080 000

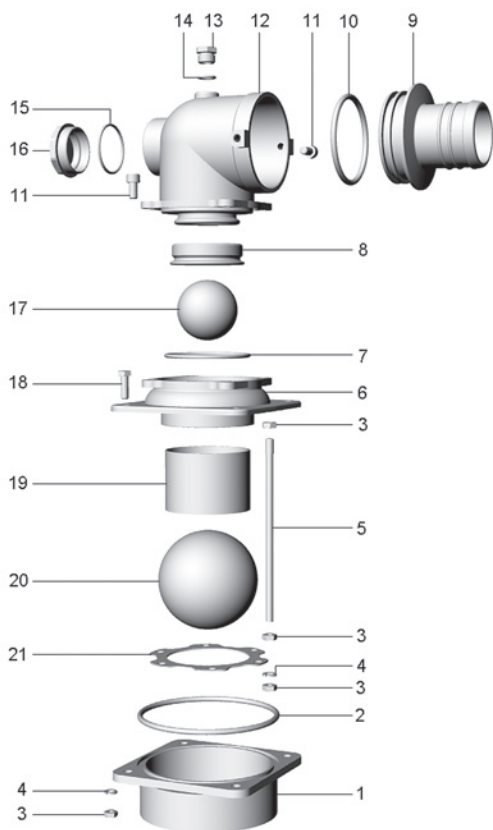

Condizioni di esercizio

Work conditions

DN	45 ÷ 80
P(Bar)	4
P(PSI)	60
T °C	-15 +80

POS.	CODICE / CODE	DENOMINAZIONE	DENOMINATION	MATERIALE	MATERIAL
1	GHAC 0160 045 003	MANICOTTO FLANGIATO 4"	FLANGED SLEEVE 4"	ACCIAIO	STEEL
1	GHAC 0160 070 003	MANICOTTO FLANGIATO 6"	FLANGED SLEEVE 6"	ACCIAIO	STEEL
2	..OR 0160 045 005	OR 210 (Øi 133,3 × 5,34) 4"	O RING 210 (Øi 133,3 × 5,34) 4"	GOMMA NBR 70	NBR 70 RUBBER
2	..OR 0074 150 011	OR 362 (Øi 158,1 × 5,34) 6"	O RING 362 (Øi 158,1 × 5,34) 6"	GOMMA NBR 70	NBR 70 RUBBER
3	DAAC 0180 045 012	DADO M8×5	NUT M8×5	ACCIAIO INOX AISI 304	AISI 304 STAINLESS STEEL
4	ROAC 0180 045 011	RONDELLA Ø14 × 8,2 × 0,8	WASHER Ø14 × 8,2 × 0,8	ACCIAIO INOX AISI 304	AISI 304 STAINLESS STEEL
5	TAZO 0160 045 018	TIRANTE M8×230 (4")	CONNECTION ROD M8×230 (4")	ACCIAIO INOX AISI 304	AISI 304 STAINLESS STEEL
5	TAZO 0160 070 018	TIRANTE M8×280 (6")	CONNECTION ROD M8×280 (6")	ACCIAIO INOX AISI 304	AISI 304 STAINLESS STEEL
6	FOZO 0160 045 001	CORPO INFERIORE 4"	LOWER BODY 4"	OTTONE UNI EN 1982	UNI EN 1982 BRASS
6	FOZO 0160 070 001	CORPO INFERIORE 6"	LOWER BODY 6"	OTTONE UNI EN 1982	UNI EN 1982 BRASS
7	..OR 0160 045 007	OR 4312 (Øi 79 × 3,53) 4"	O RING 4312 (Øi 79 × 3,53) 4"	GOMMA NBR 70	NBR 70 RUBBER
7	..OR 0160 070 007	OR 4450 (Øi 113,9 × 3,53) 6"	O RING 4450 (Øi 113,9 × 3,53) 6"	GOMMA NBR 70	NBR 70 RUBBER
8	GGOM 0240 045 019	ANELLO A LABBRO Ø60 (4")	BRIMMED GASKET Ø60 (4")	GOMMA NBR 60	NBR 60 RUBBER
8	GGOM 0240 070 019	ANELLO A LABBRO Ø80 (6")	BRIMMED GASKET Ø80 (6")	GOMMA NBR 60	NBR 60 RUBBER
9	FOZO 0240 045 07D	RACCORDO DIRITTO Ø45	STRAIGHT CONNECTION Ø45	OTTONE UNI EN 1982	UNI EN 1982 BRASS
9	FOZO 0240 050 07D	RACCORDO DIRITTO Ø50	STRAIGHT CONNECTION Ø50	OTTONE UNI EN 1982	UNI EN 1982 BRASS
9	FOZO 0240 060 07D	RACCORDO DIRITTO Ø60	STRAIGHT CONNECTION Ø60	OTTONE UNI EN 1982	UNI EN 1982 BRASS
9	FOZO 0240 075 07D	RACCORDO DIRITTO Ø75	STRAIGHT CONNECTION Ø75	OTTONE UNI EN 1982	UNI EN 1982 BRASS
9	FOZO 0240 080 07D	RACCORDO DIRITTO Ø80	STRAIGHT CONNECTION Ø80	OTTONE UNI EN 1982	UNI EN 1982 BRASS
10	..OR 0160 045 006	OR 179 (Øi 75,6 × 5,34)	O RING 179 (Øi 75,6 × 5,34)	GOMMA NBR 70	NBR 70 RUBBER
11	VTAC 0020 100 009	VITE TCEI M8×16	SCREW TCEI M8×16	ACCIAIO INOX AISI 304	AISI 304 STAINLESS STEEL
12	FOZO 0180 045 004	CORPO SUPERIORE 4"	UPPER BODY 4"	OTTONE UNI EN 1982	UNI EN 1982 BRASS
12	FOZO 0180 070 004	CORPO SUPERIORE 6"	UPPER BODY 6"	OTTONE UNI EN 1982	UNI EN 1982 BRASS
13	TOIR 1027 010 015	TAPPO 3/8"	COVER 3/8"	OTTONE UNI EN 12164	UNI EN 12164 BRASS
14	..OR 1027 006 002	OR 117 (Øi 13,1 × 2,62)	O RING 117 (Øi 13,1 × 2,62)	GOMMA NBR 70	NBR 70 RUBBER
15	..OR 0180 070 017	OR 3231 (Øi 58,4 × 2,62)	O RING 3231 (Øi 58,4 × 2,62)	GOMMA NBR 70	NBR 70 RUBBER
16	SOZO 0180 070 020	TAPPO 2"	COVER 2"	OTTONE UNI EN 12165	UNI EN 12165 BRASS
17	ARZO 0915 060 000	SFERA Ø60 (4")	BALL Ø60 (4")	POLIPROPILENE	POLYPROPYLENE
17	ARZO 0915 080 000	SFERA Ø80 (6")	BALL Ø80 (6")	POLIPROPILENE	POLYPROPYLENE
18	VTAC 0160 045 009	VITE TE M8×25	SCREW TE M8×25	ACCIAIO INOX AISI 304	AISI 304 STAINLESS STEEL
19	TAZO 0160 045 008	TUBO ACCIAIO Ø85 × 1,5 × 65 (4")	STEEL PIPE Ø85 × 1,5 × 65 (4")	ACCIAIO INOX AISI 304	AISI 304 STAINLESS STEEL
19	TAZO 0160 070 008	TUBO ACCIAIO Ø108 × 2 × 85 (6")	STEEL PIPE Ø108 × 2 × 85 (6")	ACCIAIO INOX AISI 304	AISI 304 STAINLESS STEEL
20	ARZO 0917 100 000	SFERA DI SPINTA Ø100 (4")	THRUSTING BALL Ø100 (4")	POLIETILENE	POLYETHYLENE
20	ARZO 0917 120 000	SFERA DI SPINTA Ø120 (6")	THRUSTING BALL Ø120 (6")	POLIETILENE	POLYETHYLENE
21	SAZO 0160 045 010	FLANGIA 4"	FLANGE 4"	ACCIAIO INOX AISI 304	AISI 304 STAINLESS STEEL
21	SAZO 0160 070 010	FLANGIA 6"	FLANGE 6"	ACCIAIO INOX AISI 304	AISI 304 STAINLESS STEEL